



**COLORSPACE UDMA3**



# Sanho Manufacturer's Limited Liability

Sanho warrants to the end user that this product, excluding its content and/or software supplied with the product, will be free from material defects in the manufacture, will conform to Sanho's published product specifications and be fit for normal use during the Warranty Period specified below, commencing on the date of purchase provided that the product is legally purchased on the market.

To make a warranty claim please contact Sanho at the telephone number below or at [support@hypershop.com](mailto:support@hypershop.com) within the warranty period and provide proof of purchase (showing date, place and name of the reseller) and product name, type and number. You may return the product after obtaining a Return Material Authorization number and following any other guidelines provided by our customer support. For further information, see [www.hypershop.com](http://www.hypershop.com). Sanho may at its option repair this product or provide you with an equivalent replacement. Sanho will not be liable for indirect or consequential (including loss of data), or for damage caused by improper use (including use with an incompatible device) and use not in accordance with the instructions), or by improper installation, unprofessional repair, modification or accident. This constitutes Sanho's entire liability, which will never exceed the price you paid for it, plus the necessary costs you made for the warranty claim.

Sanho products must not be used in applications where failure could threaten injury or life, such as life support systems.

National, state and local laws may grant you other rights that are not affected by this warranty.

Warranty Period: 1 Year

Sanho Corporation  
47456 Fremont Blvd.  
Fremont CA 94538, U.S.A  
Tel: +1(408)737-7878

Additional terms and conditions can be found at [www.hypershop.com](http://www.hypershop.com)

Usage of this product constitute acceptance of these terms and conditions.

# Safety Operation Instructions

We recommend that the user test the device before first use to familiarize with the functions and to ensure that the device functions as per published specifications.

The device is installed with an internal battery that is certified safe and compatible by the manufacturer. Replacing with an incompatible battery may result in short circuit and fire hazard.

Do not use the device in a moist environment and do not handle the device if your hands are wet. If liquid enters the device, immediately power off the device, remove the battery, and send it back to the dealer for repair. Never try to use a device that has been corroded by liquid, as it may result in short circuit and fire.

Carefully power off the device and remove the battery if the device produces odd smell, extreme heat and smoke. Handle with care, as the device may be very hot.

If you are not using the original AC charger provided, please make sure your charger has an output up to 10W and certified safe by your country safety commission.

The device may be hot while charging. Please charge the device in a ventilated area.

Power off the device before opening the back cover to install or remove the hard drive.

Do not place the device near heavily magnetized objects or else, data may be lost.

# Contents

Overview	1
Main Menu	3
<b>Import</b>	
Import from Memory Card	4
Import from USB Device	5
Import Menu	6
Import All	7
Incremental Import Defined	8
Set Import Destination Folder	9
Incremental Import	10
Data Verification	11
<b>File Manager</b>	
Basic Operations	12
Copy/Paste File	13
Create New Folder	14
<b>Browser</b>	
Browse Photos	15
Decoding Raw File	16
<b>Sync With External Hard Drive</b>	17
<b>Wireless File Sharing</b>	
Using WiFi File Sharing	18
WiFi data Sharing Status	19
Connecting to Existing WiFi Network	20
Accessing UDMA3 on mobile devices/computers	21
<b>Photo Recovery</b>	22
<b>Settings</b>	
View Hard Drive S.M.A.R.T. Information	23
Formatting Hard Drive	24
Firmware Upgrade	25
<b>Product Specifications</b>	26

# Overview

## Top

Card Slot Protective Cover

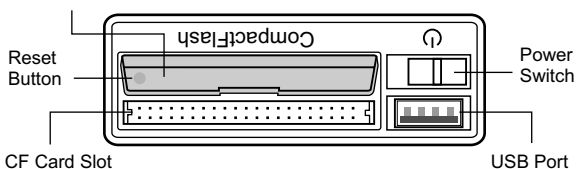

## Front

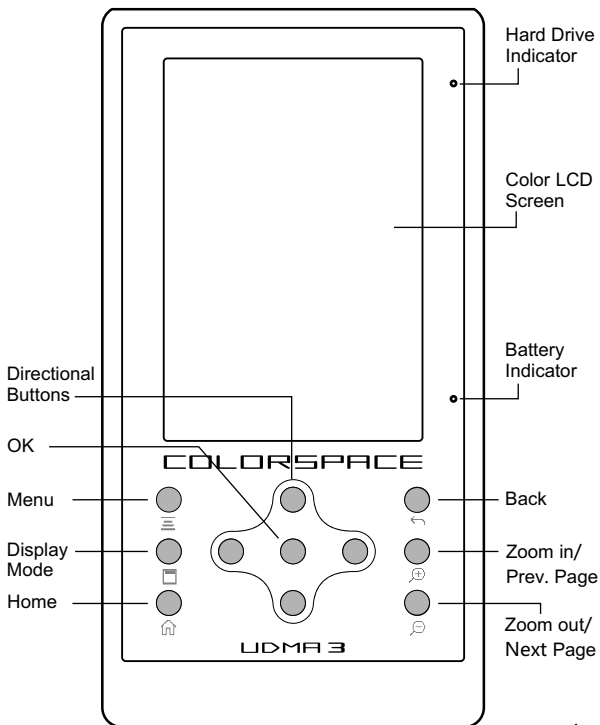

# Overview

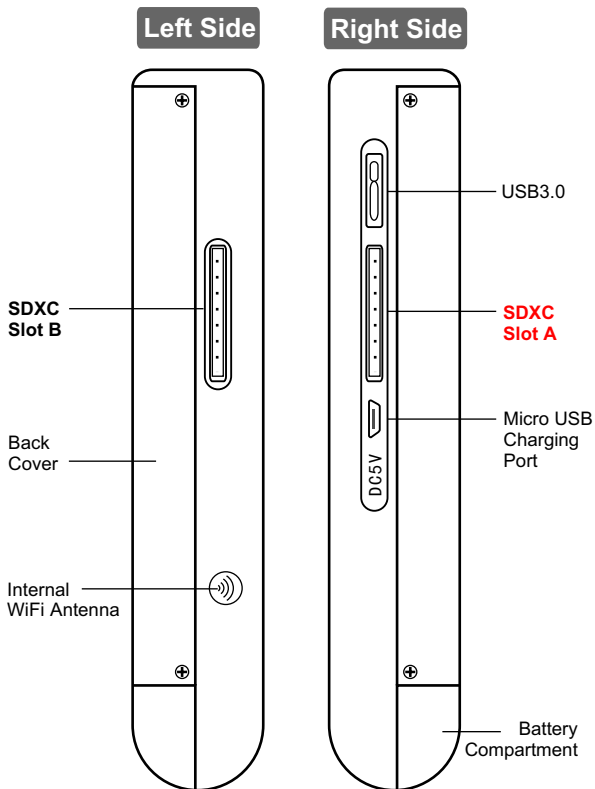



**SDXC Slot A and CF card slot cannot be used concurrently. The UDMA3 can only access one of the 2 card slots at any point of time.**

**SDXC Slot B can be used concurrently with the CF card slot.**

# Main Menu

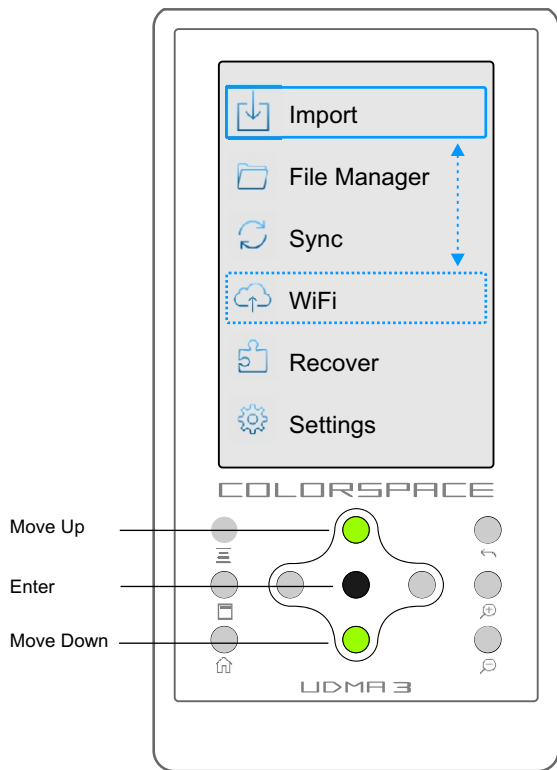
---



Return to Main Menu by pressing the  button from any screen.



# Import

## Import from Memory Card

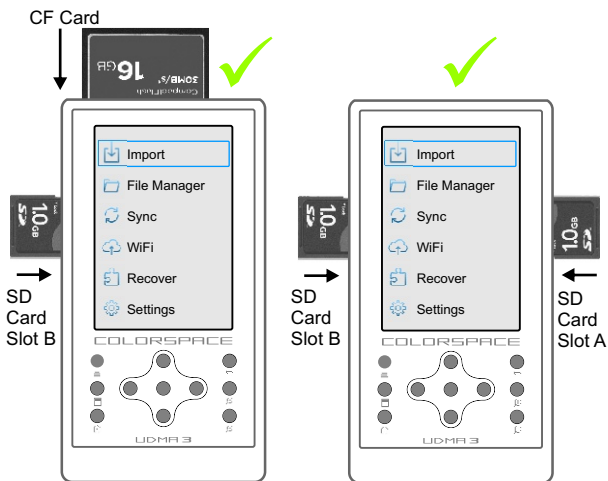

## Wrong Way

**SDXC Card Slot A and CF Card Slot cannot be used concurrently!**



# Import

## Import from USB Device



# Import

## Import Menu

Import	
Source:	
Device:	Card Reader
Capacity:	14.5GB
Path:	/W
Destination:	
Device:	HDD-C
Free Space:	900.89GB
Path:	/C/BACKUP
Options:	
Preview:	Off
Verify:	Off
Import All	←·····→ Import Incr.
☰ Menu	⊕ Select ⊕ Start

Press 'OK' button to start Import,  
Press the 'Left' or 'Right' button  
to select Import option.

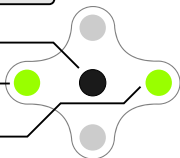

**Import All:** Copy all files from Source to Destination Folder  
**Incremental Import:** Copy only newly created files from the Source to the Destination Folder

Press the Menu button. The Settings Menu will pop up to allow user to Change Source, Change Destination, Select Visual Import Setting, File Verification Setting, Folder Name Setting.

# Import

---

## Import All

When 'Import All' is selected, a new Folder will be created in the destination location. You can define the Folder Naming Rule, i.e. name according to sequential number of based on date.

The screen will display the import progress during the operation.

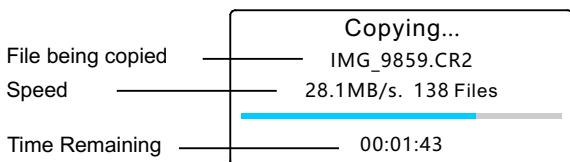

Upon completion, the screen will display Import Details.

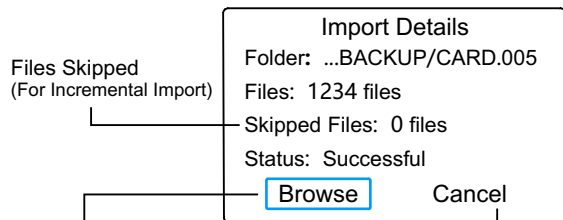

Press 'OK' button to start browsing the files, Select the Left or Right button to change your option. Select 'Cancel' to return to the Main Menu.

**If 'Import All' is selected and carried out twice from the same memory card, two folders will be created in the destination location, and the files will be imported twice, utilizing twice the memory space in the destination location.**

# Import

---

## Incremental Import Defined

For Incremental Import, the device will first identify if the file to be copied exists in the destination folder (by looking at the file name). If the file already exist in the destination folder, the device will skip the file and move on to another file.

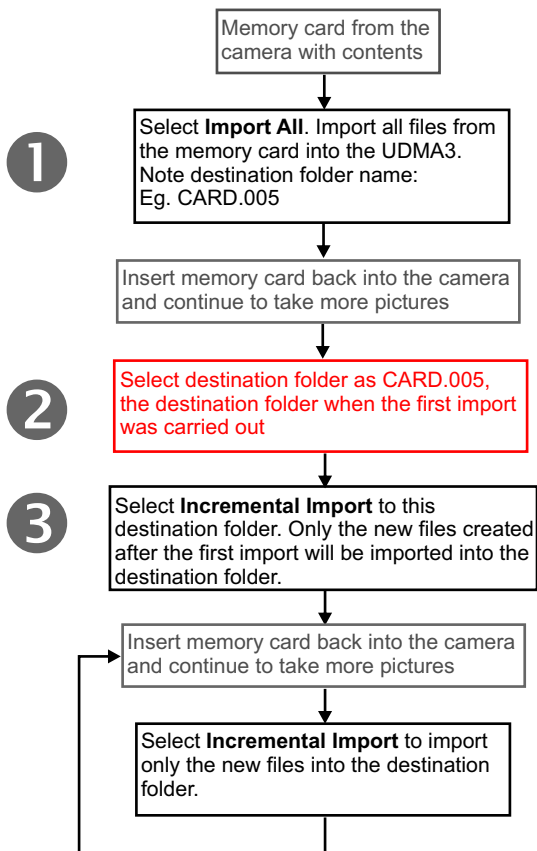

# Import

## Set Import

Source: **Import**

Device: Card Reader  
Capacity: 14.5GB  
Path: /W

Destination:

Device: HDD-C  
Free Space: 900.89GB  
Path: **Select Folder**

Options:

Preview: Off  
Verify: Off

Import All ..... Import Incr

Menu Select Start

Destination Folder

**On the first Incremental Import, the device will prompt you to select a destination folder.**

Press 'Menu'.  
When the Settings Menu pops up, Select 'Change Destinations'.

Settings

Change Source >  
**Change Destination >**  
Visual Import >  
Verify >  
Folder Name >

Then press the 'Right' button

Change Destination

HDD-C  
**Select Folder**

/C/BACKUP

CARD.001  
CARD.002  
CARD.003  
CARD.004  
**CARD.005**

Select destination folder and press 'OK'

# Import

## Set Import

Ensure that the correct Destination Folder is selected before starting import.

Import	
Source:	
Device:	Card Reader
Capacity:	14.5GB
Path:	/W
Destination:	
Device:	HDD-C
Free Space:	900.89GB
Path:	...BACKUP/CARD.005
Options:	
Preview:	Off
Verify:	Off
Import All	.....▶ Import Incr
☰ Menu	⊕ Select ⊕ Start

Press 'OK' to start import.

Use the 'Left' and 'Right' button to change import method.

**Downloading photos from Memory Card used on Camera: While using Incremental Import, always define a NEW destination folder whenever the memory card has been reformatted to capture new pictures. The camera repeats file names when capturing picture files in a newly reformatted memory card.**

**In Incremental Import mode, the system will skip importing file names that already exist in the destination folder.**

**Using a new destination folder will ensure that the system does not skip importing any file by error.**

# Import

## Data Verification

Data integrity is paramount importance to every user. The UDMA3 is able to safely import and store data. In addition, the UDMA3 provides a data Verification feature to verify that the data is imported correctly by comparing the data from the source to the imported data in the destination location. You can select:

### Quick Verification:

Verify only the first 2M header of every file. If the file is less than 2M header, complete verification will take place.

### Full Verification:

Complete data verification of the entire file.

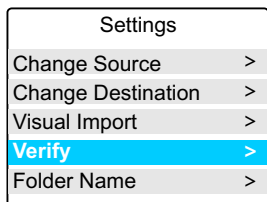

Press 'OK' on selected verification option

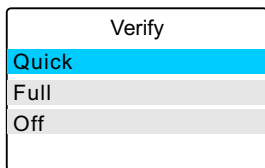

**Data Verification DOES NOT prevent data loss as a result of hard drive or computer failure. Please perform addition back up of important data in a different device.**



# File Manager

## Basic Operations

From the Main Menu, select 'File Manager'

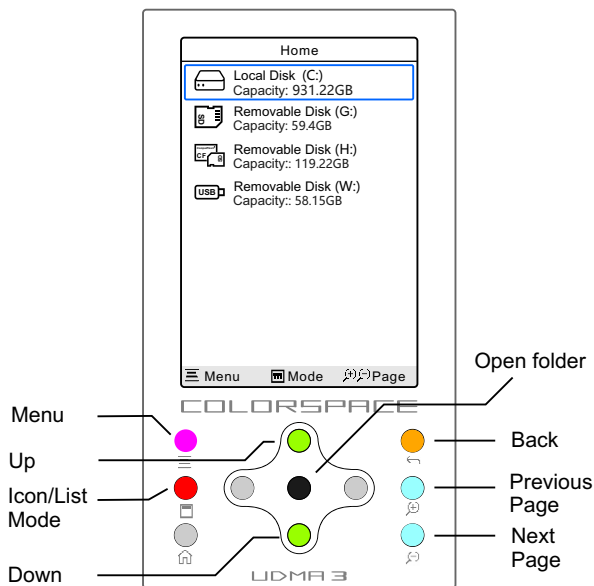

When browsing photo, select a photo by pressing the 'OK' button. Once you are in the photo, navigate as follow:

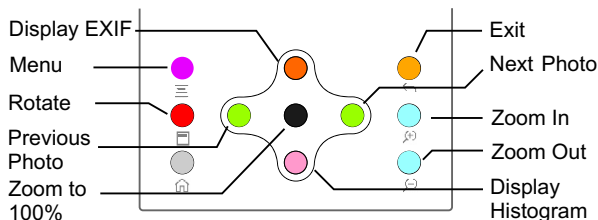

# File Manager

## Copy/Paste File

In the File Manager list, press the  button. A sub-menu page will pop up. Select 'Edit'.

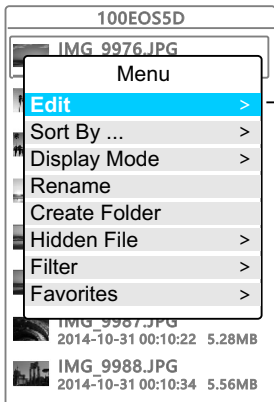

In the Edit mode, a check box will show on the right of each file.

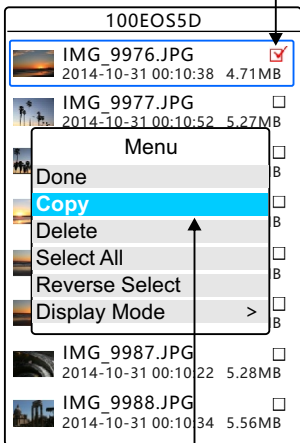

Select the files to be edited, press 'OK' to mark the check box to select files. Press the  button, and select 'Copy'.

Next, browse for the destination folder, press the  button, and select 'Paste'.

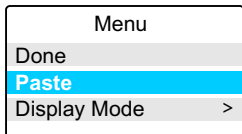

# File Manager

## Create New Folder

In the File Manager list, press the  button, select 'Create Folder'

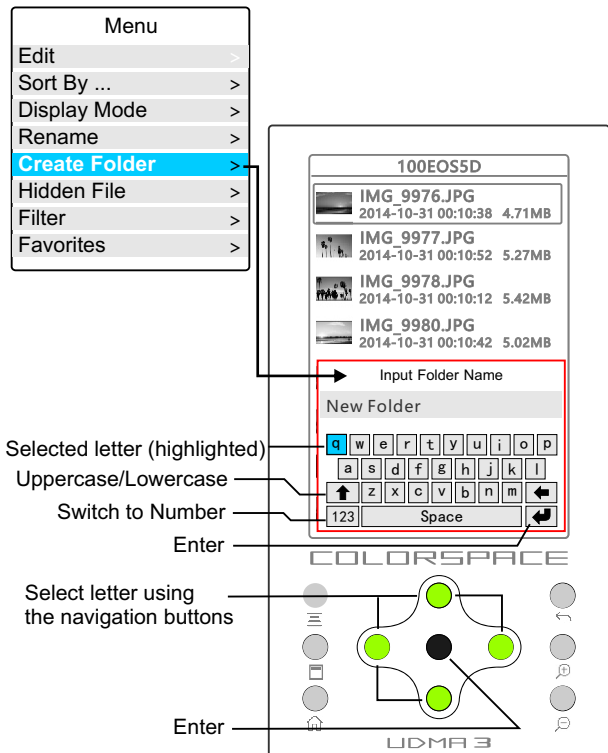

Input a new folder name by typing on the keyboard with the navigation buttons and 'OK' button.

# Browser

Select a photo for viewing. When the photo is displayed in full screen, you can use keypad button to browse the photo as follow:

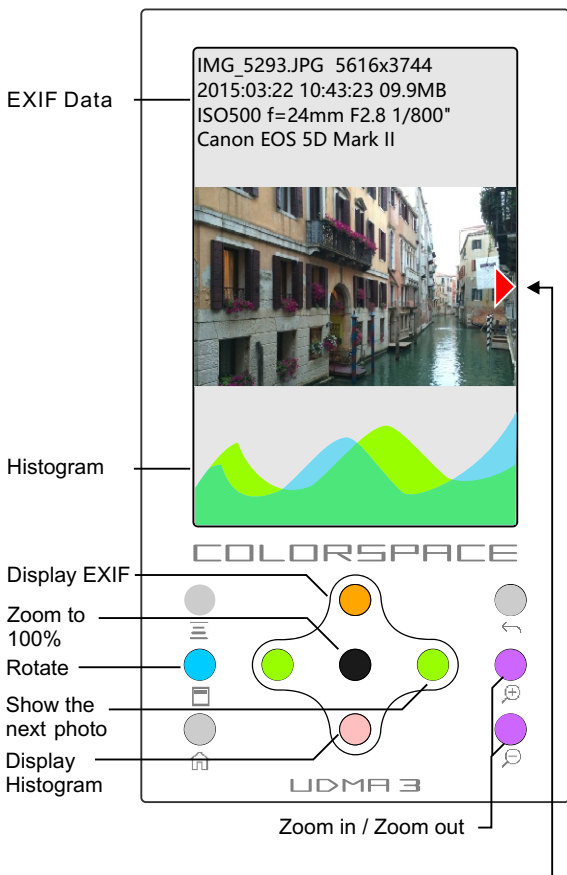

**Right arrow:** The next picture has already been loaded and ready to view. Press the 'Right' button to view the next photo.

# Browser

## Decoding Raw Files

A professional camera photo has two sets of data for each photo file. A reduced size photo file for quick preview and a true RAW photo file that contains all the data captured from the camera sensor.

UDMA3 is able to decode RAW data from the camera sensor contained within a RAW photo.

When browsing a RAW photo, press the  button,

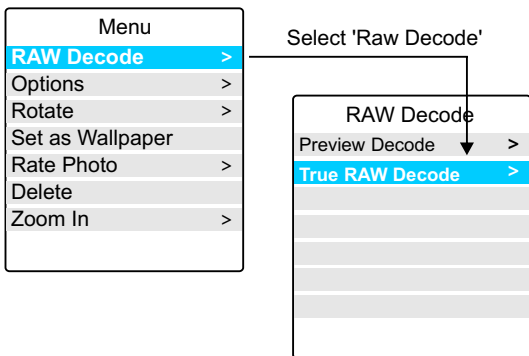

Due to the large size of a RAW file, the decoding process may take a couple of seconds. For example, a CR2 format photo from Canon 5D Mark II may take only 3s to load the preview photo but takes 43s to decode the RAW photo.

**The color of a decoded RAW photo may look slightly different from the color of a preview photo as the color may not have been corrected in the RAW decoding process.**

# Sync with External Hard Drive

The UDMA3 data can be backed up and synchronized with another external hard drive. During the one-way sync process, from the UDMA3 to another external hard drive, if the same filename is detected in the external hard drive, the file will not be copied to the external hard drive.

We recommend syncing your data to another hard drive periodically for additional back up.

Connect a FAT32 formatted external hard drive to the USB port on the UDMA3:



**You can format the external hard drive to FAT32 format using the UDMA3.**

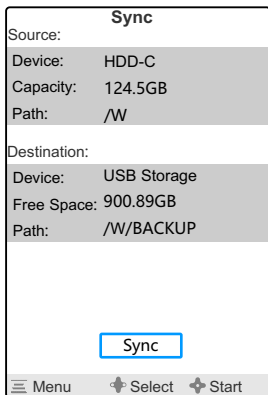

On the Main Menu, select 'Sync'. In the Sync Menu, make sure the source and destination location is correct. Select 'OK' to start syncing.

**Connect external power to UDMA3 during the Sync process.**

# Wireless File Sharing

## Using WiFi File Sharing

UDMA3 has a WiFi wireless file sharing capability by creating its own WiFi hotspot. You can access the data in the UDMA3 via mobile devices like smart phones, tablets and laptops. From the Main Menu select 'WiFi'

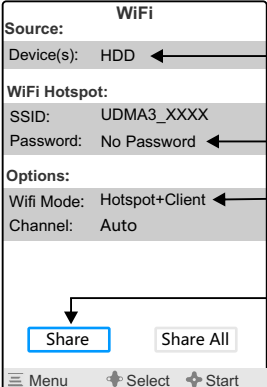

The screenshot shows the 'WiFi' settings menu with the following options:

- Source: Device(s): HDD
- WiFi Hotspot: SSID: UDMA3\_XXXX, Password: No Password
- Options: Wifi Mode: Hotspot+Client, Channel: Auto
- Buttons: Share, Share All
- Bottom bar: Menu, Select, Start

Annotations:

- Arrow pointing to 'Device(s): HDD': Only devices listed here will be shared.
- Arrow pointing to 'Password: No Password': Data owner can set password to restrict access
- Arrow pointing to 'Wifi Mode: Hotspot+Client': 'Client' mode allows UDMA3 to join an existing wireless network
- Arrow pointing to the 'Share' button: To conserve power, the system will by default only share files in the internal hard drive.

You can choose to share all devices. This would however consume more power and reduce UDMA3 working duration.

Press  button, select 'Devices', then select devices that you wish to share wirelessly.

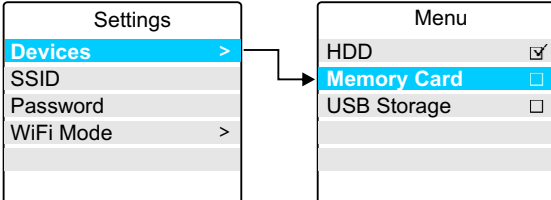

The screenshot shows two screens:

- Settings:** Devices (highlighted), SSID, Password, WiFi Mode
- Menu:** HDD (checked), Memory Card, USB Storage

An arrow points from the 'Devices' option in the Settings screen to the 'Memory Card' option in the Menu screen.

# Wireless File Sharing

## WiFi Data Sharing Status

Once the system is in the WiFi data-sharing mode, the screen will then display the following:

Ad-hoc WiFi hotspot created by UDMA3. Mobile devices and computer can access the data in UDMA3 via the Ad-hoc WiFi hot spot. There is no need for internet or existing WiFi network for this feature to work.

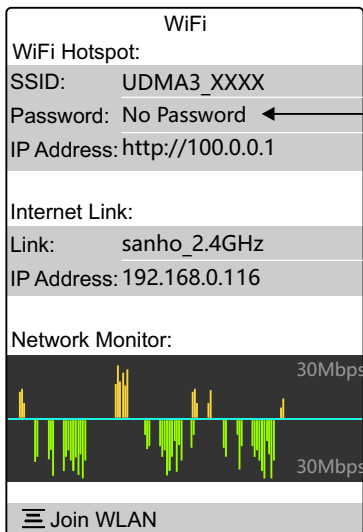

You can set password for secure access

Join existing WiFi Network at home or at work. Computer and mobile devices in the same network will be able to access the data in UDMA3.

**Please be warned that unauthorized persons can intercept data transfer in a WiFi network. Therefore, it is NOT advised to wirelessly share data in a public WiFi network, especially when there is no access password access set for the network.**



# Wireless File Sharing

## Connecting to Existing WiFi Network

Press  button to join existing WiFi network. UDMA3 will scan and show all available networks.

Select a WiFi Network →

Press 'OK' ↓

Key in Password →

Press  once complete

Upper/Lower case ↗

Press  to cancel joining WLAN.

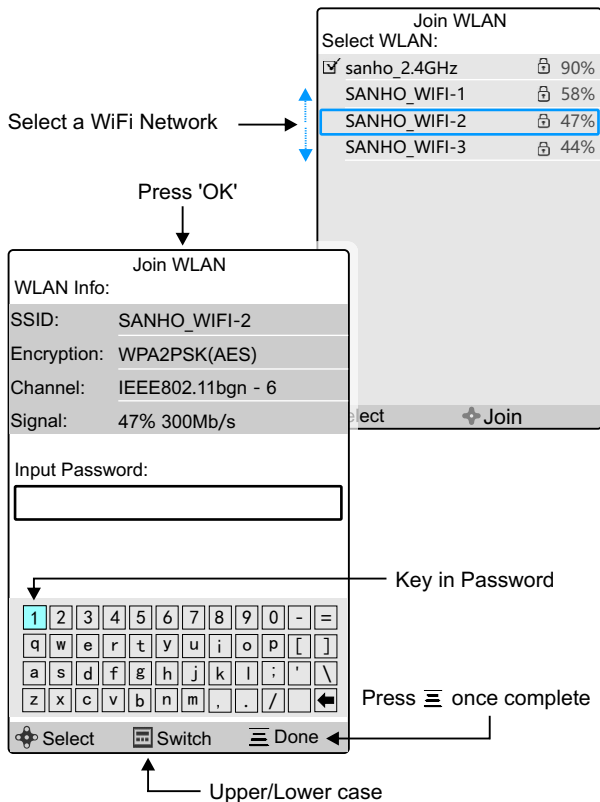

**Join WLAN**

Select WLAN:

<input checked="" type="checkbox"/>	sanho_2.4GHz	🔒	90%
<input type="checkbox"/>	SANHO_WIFI-1	🔒	58%
<input checked="" type="checkbox"/>	SANHO_WIFI-2	🔒	47%
<input type="checkbox"/>	SANHO_WIFI-3	🔒	44%

WLAN Info:

SSID: SANHO\_WIFI-2

Encryption: WPA2PSK(AES)

Channel: IEEE802.11bgn - 6

Signal: 47% 300Mb/s

Input Password:

1 2 3 4 5 6 7 8 9 0 - =

q w e r t y u i o p [ ]

a s d f g h j k l ; ' \

z x c v b n m , . /

Select Switch Done

# Wireless File Sharing

## Accessing UDMA3 on mobile devices/computers

On your mobile phone or computer, go to <Settings>



Select <WiFi>, then select the Ad-hoc WiFi network created by UDMA3. For example, in this case is 'UDMA3\_E4E6'



Install the iUSBport App in your mobile device to access the UDMA3.

**In the event the App is not available for some devices or computer, the UDMA3 can be accessed via Chrome or Safari browser. Enter the url <http://100.0.0.1> or <ftp://100.0.0.1> in the browser.**

# Photo Recover

---

This function can recover photos that have been accidentally deleted from a memory card, into the UDMA3.

Select 'Recover' from the Main Menu. The recovered photos will be copied and store in the 'Recover' folder in the UDMA3. UDMA3 will not copy the recovered photos back into the memory card.

The following photos format can be recovered by UDMA3:

Camera Model	Photos Format
CANON	CR2/TIF/CRW
NIKON	NEF
PENTAX	DNG/PEF
SAMSUNG	PEF
RICOH	DNG
SONY	SR2/ARW
OLYMPUS	CRF
PANASONIC	RAW
MAMIYA	MEF

**Once you have discovered that there are photos in a memory card that has been accidentally deleted, please refrain from using the memory card and recover the photos with the UDMA3 immediately. If you have overwritten the memory card with new files, you may not be able to recover the photos.**

# Settings

## View Hard Drive S.M.A.R.T. Information

Hard drive conditions may deteriorate over time from prolonged usage. This feature allows the user to check the conditions of a mechanical hard drive installed in the UDMA3.

**S.M.A.R.T. stands for Self-Monitoring, Analysis and Reporting Technology. This feature detects and records any defect and foreseeable failures of the hard drive and warns user of any failure that may result in data loss.**

From the Main Menu, select 'Settings', then 'HDD'

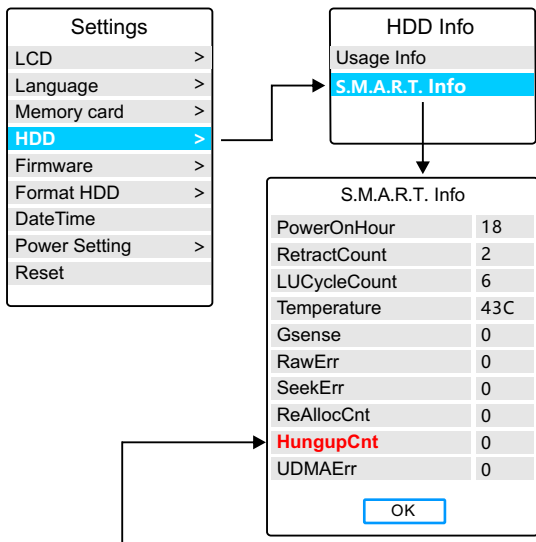

**If the 'HungupCnt' reading exceeds 10, please contact customer service and send us the complete S.M.A.R.T. information.**

# Settings

## Formatting Hard Drive

**Warning: Reformatting the hard drive will erase all files and data in the hard drive. Please connect the UDMA3 to external power supply if the battery power is low. The hard drive may be damaged if power supply is interrupted during the process.**

From the Main Menu, select 'Settings', then 'Format HDD'

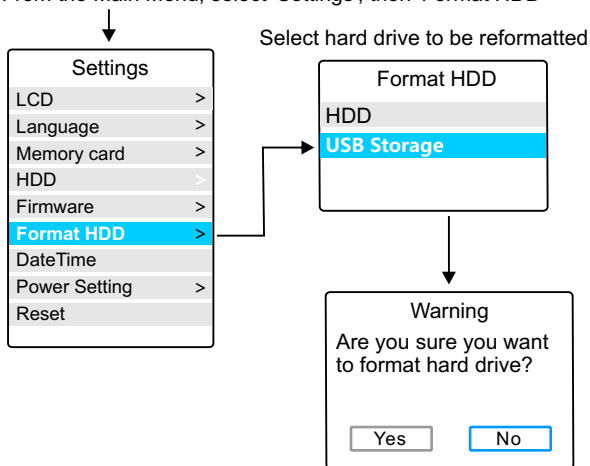

The system will prompt you twice to warn you about data loss from reformatting. Select 'Yes' to proceed. Reformatting the hard drive will erase all data and format the hard drive to a single partition FAT32 format.

A confirmation message will display once completed.

# Settings

## Firmware Upgrade

Please download the latest firmware from [www.hyperdrive.com](http://www.hyperdrive.com). Store the SPF firmware file in a memory card. Then insert the memory card into UDMA3.

From the Main Menu, select 'Settings'. Then, select 'Firmware' > 'Firmware Update' .

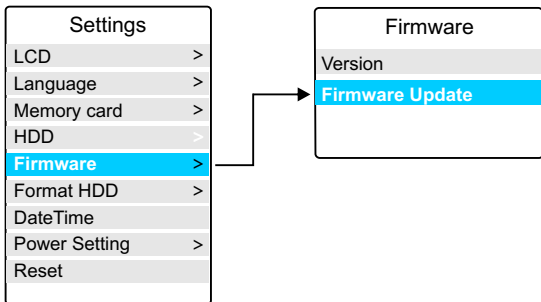

Select the SPF firmware file from the file list window.

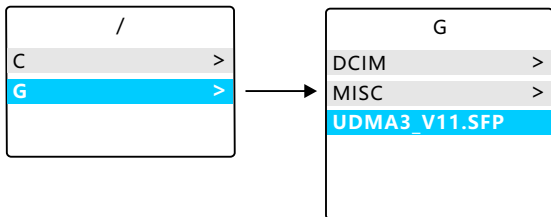

Restart the UDMA3 once the firmware upgrade has completed.

**Please do not remove the memory card and ensure sufficient battery power or plug in the external power supply. Interruption during firmware upgrade may cause device malfunction.**

# Product Specifications

---

<b>Memory Card Slot</b>	1 x Compact Flash Type I 2 x SD/MMC/SDHC/SDXC
<b>USB Port</b>	1 x USB3.0 Super Speed 5Gbps 1 x USB2.0 High Speed 480Mbps
<b>Hard Drive Port</b>	SATA, 2.5 inch, 9.5mm thickness (SSD hard drive compatible)
<b>Built-In WiFi Adapter</b>	WiFi IEEE802.11n 150 Mbps
<b>Charging Port</b>	Micro USB DC 5V/2A
<b>LCD</b>	3.5" TFT 320x480 Color LCD
<b>Battery Life</b>	2600mAh with Coulomb Meter Import Photos duration: 120mins
<b>Dimensions</b>	73mm x 136mm x 26mm

# **COLORSPACE UDMA3**

User Manual English V1.0  
Copyright 2015 Sanho Corporation